



Operation manual

R32 split series



FTXP20L2V1B
FTXP25L2V1B
FTXP35L2V1B
FTXP50L2V1B
FTXP60L2V1B
FTXP71L2V1B

Operation manual
R32 split series

English

Table of Contents

1	About the documentation	2
1.1	About this document.....	2
2	About the system	2
2.1	Indoor unit	2
2.2	About the user interface	3
2.2.1	Components: User interface	3
2.2.2	Status: User interface LCD	3
2.2.3	To operate the user interface.....	4
3	Before operation	4
3.1	To fix the user interface to the wall.....	4
3.2	To insert the batteries.....	4
3.3	To switch between Fahrenheit and Celsius.....	4
3.4	To turn on the power supply.....	4
4	Operation	4
4.1	Operation range	4
4.2	When to use which feature.....	5
4.3	Operation mode and temperature setpoint.....	5
4.3.1	To start/stop operation and to set the temperature.....	5
4.3.2	Airflow rate	5
4.3.3	Airflow direction.....	6
4.3.4	Comfort airflow operation.....	6
4.3.5	Powerful operation.....	6
4.3.6	Econo operation.....	7
4.3.7	OFF/ON timer operation	7
5	Energy saving and optimum operation	8
6	Maintenance and service	8
6.1	Overview: Maintenance and service	8
6.2	To clean the indoor unit and user interface.....	9
6.3	To clean the front panel.....	9
6.4	To open the front panel	9
6.5	To clean the air filters	9
6.6	To clean the titanium apatite deodorizing filter.....	10
6.7	To replace the titanium apatite deodorizing filter.....	10
6.8	To close the front panel.....	10
6.9	To take following items into account before a long idle period..	10
7	Troubleshooting	10
7.1	Symptoms that are NOT system malfunctions	11
7.1.1	Symptom: A sound like water flowing is heard	11
7.1.2	Symptom: A blowing sound is heard.....	11
7.1.3	Symptom: A ticking sound is heard.....	11
7.1.4	Symptom: A whistling sound is heard	11
7.1.5	Symptom: A clicking sound during operation or idle time is heard	11
7.1.6	Symptom: A clapping sound is heard	11
7.1.7	Symptom: The units can give off odours.....	11
7.1.8	Symptom: The outdoor fan rotates while the air conditioner is not in operation	12
7.2	Solving problems based on error codes.....	12
8	Disposal	12

1 About the documentation

1.1 About this document

Thank you for purchasing this product. Please:

- Keep the documentation for future reference.

Target audience

End users



INFORMATION

This appliance is intended to be used by expert or trained users in shops, in light industry, and on farms, or for commercial and household use by lay persons.

Documentation set

This document is part of a documentation set. The complete set consists of:

- **General safety precautions:**
 - Safety instructions that you must read before operating your system
 - Format: Paper (in the box of the indoor unit)
- **Operation manual:**
 - Quick guide for basic usage
 - Format: Paper (in the box of the indoor unit)
- **User reference guide:**
 - Detailed step-by-step instructions and background information for basic and advanced usage
 - Format: Digital files on <http://www.daikineurope.com/support-and-manuals/product-information/>

Latest revisions of the supplied documentation may be available on the regional Daikin website or via your installer.

The original documentation is written in English. All other languages are translations.

2 About the system



WARNING: FLAMMABLE MATERIAL

The refrigerant inside this unit is mildly flammable.

2.1 Indoor unit



INFORMATION

The following figures are just examples and may NOT completely match your system layout.



CAUTION

Do NOT insert fingers, rods or other objects into the air inlet or outlet. When the fan is rotating at high speed, it will cause injury.



INFORMATION

The sound pressure level is less than 70 dBA.

WARNING

- Do not modify, disassemble, remove, reinstall or repair the unit yourself as incorrect dismantling or installation may cause an electric shock or fire. Contact your dealer.
- In case of accidental refrigerant leaks, make sure there are no naked flames. The refrigerant itself is entirely safe, non-toxic and mildly flammable, but it will generate toxic gas when it accidentally leaks into a room where combustible air from fan heaters, gas cookers, etc. is present. Always have qualified service personnel confirm that the point of leakage has been repaired or corrected before resuming operation.

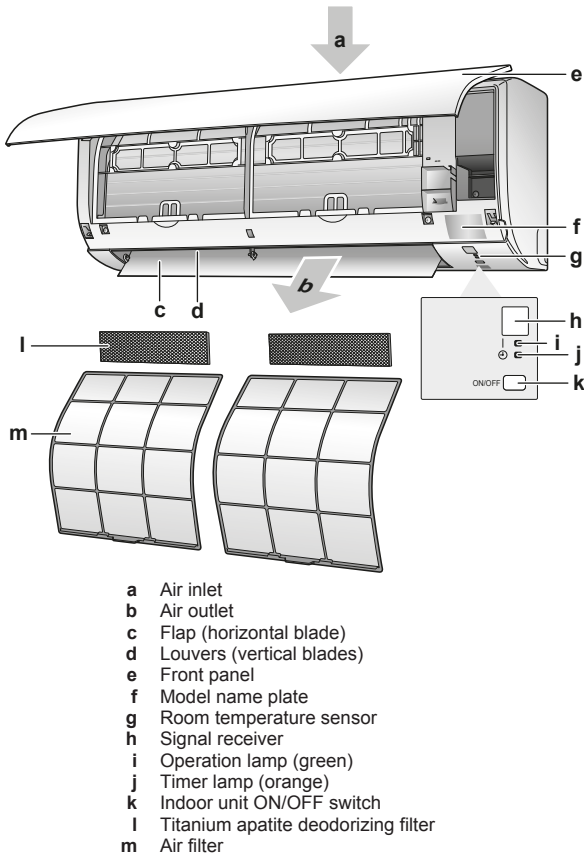

- a Air inlet
- b Air outlet
- c Flap (horizontal blade)
- d Louvers (vertical blades)
- e Front panel
- f Model name plate
- g Room temperature sensor
- h Signal receiver
- i Operation lamp (green)
- j Timer lamp (orange)
- k Indoor unit ON/OFF switch
- l Titanium apatite deodorizing filter
- m Air filter

ON/OFF button

If the user interface is missing, you can use the ON/OFF button on the indoor unit to start/stop operation. When operation is started using this button, the following settings are used:

- Operation mode = Automatic
- Temperature setting = 25°C
- Airflow rate = Automatic

2.2 About the user interface

- Direct sunlight.** Do NOT expose the user interface to direct sunlight.
- Dust.** Dust on the signal transmitter or receiver will reduce sensitivity. Wipe off dust with a soft cloth.
- Fluorescent lights.** Signal communication might be disabled if fluorescent lamps are in the room. In that case, contact your installer.
- Other appliances.** If the user interface signals operate other appliances, move the other appliances, or contact your installer.
- Curtains.** Make sure that the signal between the unit and the user interface is NOT blocked by curtains or other objects.

NOTICE

- Do NOT drop the user interface.
- Do NOT let the user interface get wet.

2.2.1 Components: User interface

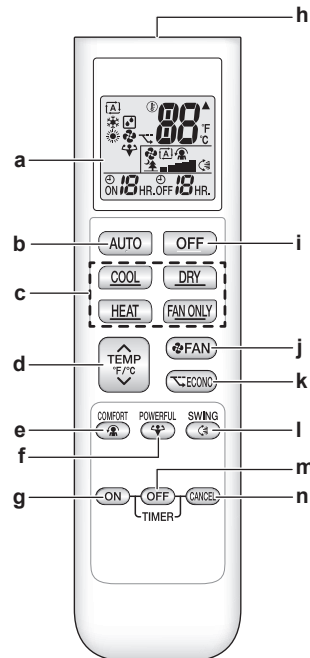

- a Display (LCD)
- b Auto button
- c Direct operation button
- d Temperature adjustment button
- e Comfort button
- f Powerful button
- g ON timer button
- h Signal transmitter
- i OFF button (Night set mode)
- j Fan setting button
- k Econo button
- l Swing button
- m OFF timer button
- n Timer cancel button

2.2.2 Status: User interface LCD

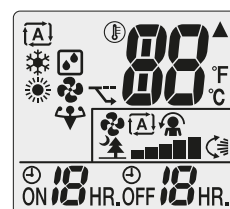

Icon	Description
	Operation mode = Automatic
	Operation mode = Drying
	Operation mode = Heating
	Operation mode = Cooling
	Operation mode = Fan only
	Powerful operation is active
	Econo operation is active
	The indoor unit receives a signal from the user interface

3 Before operation

Icon	Description
	Current temperature setting
	Airflow rate = Automatic
	Airflow rate = Indoor unit quiet
	Airflow rate = High
	Airflow rate = Medium high
	Airflow rate = Medium
	Airflow rate = Medium low
	Airflow rate = Low
	Comfort operation is active
	Auto vertical swing is active
	ON timer is active
	OFF timer is active

2.2.3 To operate the user interface

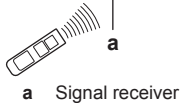

- 1 Aim the signal transmitter at the signal receiver on the indoor unit (maximum distance for communication is 7 m).

Result: When the indoor unit receives a signal from the user interface, you will hear a sound:

Sound	Description
Beep-beep	Operation starts.
Beep	Setting changes.
Long beep	Operation stops.

3 Before operation

3.1 To fix the user interface to the wall

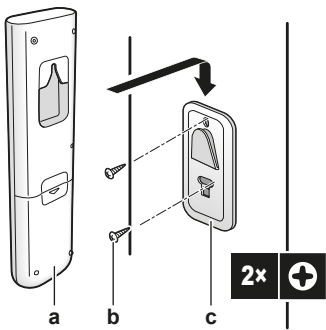

- 1 Choose a place where the signals reach the unit.

- 2 Attach the holder with screws to the wall or a similar location.
- 3 Hang the user interface on the user interface holder.

3.2 To insert the batteries

The batteries will last for about 1 year.

- 1 Remove the back cover.
- 2 Insert both batteries at once.
- 3 Put the cover back.

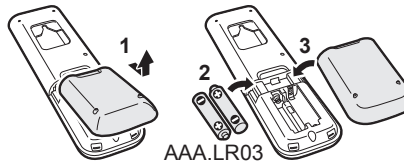

3.3 To switch between Fahrenheit and Celsius

Change this setting only when the temperature is displayed.

- 1 Press **TEMP** and **ON** simultaneously for about 5 seconds.

Result: The setting changes.

3.4 To turn on the power supply

- 1 Turn the circuit breaker on.

Result: The flap of the indoor unit will open and close to set the reference position.

4 Operation

4.1 Operation range

Use the system in the following temperature and humidity ranges for safe and effective operation.

Operation mode	Operation range
Cooling ^{(a)(b)}	<ul style="list-style-type: none"> Outdoor temperature: -10~46°C Indoor temperature: 18~32°C Indoor humidity: ≤80%
Heating ^(a)	<ul style="list-style-type: none"> Outdoor temperature: -15~24°C Indoor temperature: 10~30°C
Drying ^(a)	<ul style="list-style-type: none"> Outdoor temperature: -10~46°C Indoor temperature: 18~32°C Indoor humidity: ≤80%

If operated outside the operation range:

- (a) A safety device might stop the operation of the system.
- (b) Condensation might occur on the indoor unit and drip.

4.2 When to use which feature

You can use the following table to determine which features to use:

Feature	Tasks
Basic features	
Operation modes and temperature	To start/stop the system and to set the temperature: <ul style="list-style-type: none"> Heat up or cool down a room. Blow air in a room without heating or cooling. Decrease the humidity in a room. In Automatic mode, automatically select an appropriate temperature and operation mode.
Airflow direction	To adjust the airflow direction (swing or fixed position).
Airflow rate	To adjust the amount of air blown into the room. To run more quietly.
Advanced features	
Econo	To use the system when you are also using other power-consuming appliances. To save energy.
Comfort	To provide a comfortable airflow that does NOT come in direct contact with people.
Powerful	To cool down or heat up the room quickly.
ON timer + OFF	To automatically turn ON or OFF the system.

4.3 Operation mode and temperature setpoint

When. Adjust the system operation mode, and set the temperature when you want to:

- Heat up or cool down a room
- Blow air in a room without heating or cooling
- Decrease the humidity in a room

What. The system operates differently depending on the user selection.

Setting	Description
Automatic	The system cools down or heats up a room to the temperature setpoint. It automatically switches between cooling and heating if necessary.
Drying	The system decreases the humidity in a room without changing the temperature.
Heating	The system heats up a room to the temperature setpoint.
Cooling	The system cools down a room to the temperature setpoint.
Fan	The system only controls the airflow (airflow rate and airflow direction). The system does NOT control the temperature.

Additional info:

- Outside temperature.** The system's cooling or heating effect decreases when the outside temperature is too high or too low.
- Defrost operation.** During heating operation, frost might occur on the outdoor unit and decrease the heating capacity. In that case, the system automatically switches to defrosting operation to remove the frost. During defrosting operation, hot air is NOT blown from the indoor unit.

4.3.1 To start/stop operation and to set the temperature

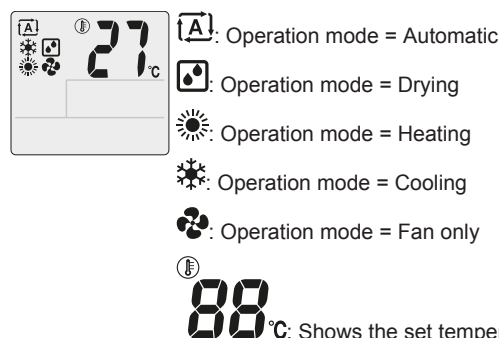

- Start operation by pressing one of the following buttons.

Result: The operation lamp lights up.

Mode	Press	Result
Automatic operation		
Cooling operation		
Drying operation		
Heating operation		
Fan only operation		

- Press or on the button one or more times to set the temperature.

Note: When using drying or fan only operation mode, you CANNOT adjust the temperature.

Cooling operation	Heating operation	Automatic operation	Drying or fan only operation
18~32°C	10~30°C	18~30°C	—

- Press to stop operation.

Result: The operation lamp goes off.

4.3.2 Airflow rate

Note: If the unit reach the temperature set point in cooling, heating or automatic mode. Fan will stop operating.

- Press to choose:

	5 airflow rate levels, from "■" to "■"
	Automatic operation
	Indoor unit quiet operation. When the airflow is set to "■", the noise from the unit will be reduced.

Note: When using **drying** operation mode, you CANNOT adjust the airflow rate setting.

4 Operation

To adjust the airflow rate

- 1 Press to change the airflow setting as follows:



4.3.3 Airflow direction

When. Adjust the airflow direction as desired.

What. The system directs the airflow differently, depending on the user selection (swinging or fixed position). It does so by moving the vertical blades.

Setting	Airflow direction
Vertical auto swing	Moves up and down.
[—]	Stays in a fixed position.

CAUTION

- ALWAYS use a user interface to adjust the angle of the flap. When the flap is swinging and you move it forcibly by hand, the mechanism will break.
- Be careful when adjusting the louvers. Inside the air outlet, a fan is rotating at high speed.

Note: The movable range of the flap varies according to the operation mode. The flap will stop at the upper position when the airflow rate is changed to low during the up and down swing setting.

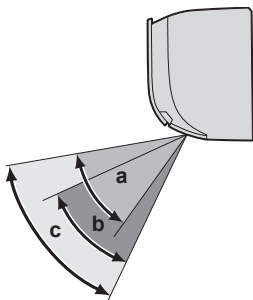

- a Flap range in cooling or drying operation
- b Flap range in heating operation
- c Flap range in fan only operation

To adjust the airflow direction

- 1 To use auto swing, press .

Result: will appear on the LCD.

Result: The flap (horizontal blade) will begin to swing.

- 2 To use fixed position, press when the flap reaches the desired position.

Result: disappears from the LCD.

To adjust the louvers (vertical blades)

- 1 Hold 1 or both knobs and move the louvers.

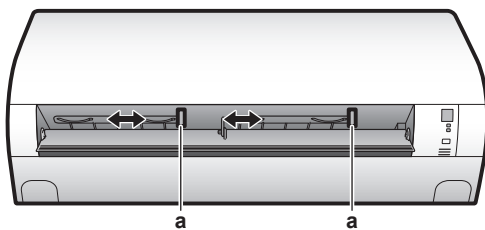

a Knobs

INFORMATION

When the unit is installed in a corner of a room, the direction of the louvers should be facing away from the wall. Efficiency will drop if a wall blocks the air.

4.3.4 Comfort airflow operation

This operation can be used in **Heating** or **Cooling** operation mode. It will provide a comfortable wind that will NOT come in direct contact with people. The system automatically sets the fixed airflow position upward in Cooling and downward in Heating operation mode.

INFORMATION

Powerful and Comfort airflow operation CANNOT be used at the same time. The last selected function takes priority. If the Vertical automatic swing is selected, Comfort airflow operation will be cancelled.

To start/stop Comfort airflow operation

- 1 Press to start.

Result: The flap position will change, is displayed on the LCD, and the airflow rate is set to automatic.

Mode	Position of flap...
Cooling/Drying	Up
Heating	Down

Note: Comfort airflow operation is NOT available in Fan only mode.

- 2 Press to stop.

Result: The flap will return to the position from before the Comfort airflow mode; disappears from the LCD.

4.3.5 Powerful operation

This operation quickly maximizes the cooling/heating effect in any operation mode. You can get the maximum capacity.

INFORMATION

Powerful operation CANNOT be used together with Econo and Comfort airflow operation. The last selected function takes priority.

Powerful operation will NOT increase the capacity of the unit if it already operates at maximum capacity.

To start/stop Powerful operation



- 1 Press to start.

Result: is displayed on the LCD. Powerful operation runs for 20 minutes; after that, operation returns to the previously set mode.

Mode	Airflow rate
Cooling/Heating/Automatic	<ul style="list-style-type: none"> • To maximize the cooling/heating effect, the capacity of outdoor unit is increased. • The airflow rate is fixed to the maximum setting. <p>The temperature and airflow settings CANNOT be changed.</p>
Drying	<ul style="list-style-type: none"> • The temperature setting is lowered by 2.5°C. • The airflow rate is slightly increased.
Fan only	The airflow rate is fixed to the maximum setting.

- 2 Press  to stop.

Result:  disappears from the LCD.

Note: Powerful operation can only be set when the unit is running. Press  to cancel this mode;  disappears from the LCD.

4.3.6 Econo operation

This is a function which enables efficient operation by limiting the maximum power consumption value. This function is useful for cases in which attention should be paid to ensure a circuit breaker will not trip when the product runs alongside other appliances.

INFORMATION

- Powerful and Econo operation CANNOT be used at the same time. The last selected function takes priority.
- Econo operation reduces power consumption of the outdoor unit by limiting the rotation speed of the compressor. If power consumption is already low, Econo operation will NOT further reduce power consumption.

To start/stop Econo operation

- 1 Press  to start.

Result:  is displayed on the LCD.

Note: Econo operation is NOT available in Fan only mode.

- 2 Press  to stop.

Result:  disappears from the LCD.

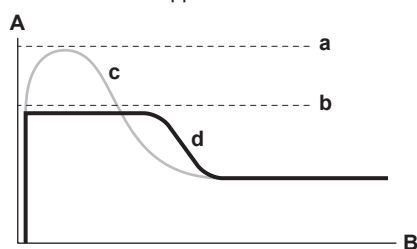

- A** Running current and power consumption
B Time
a Maximum during normal operation
b Maximum during Econo operation
c Normal operation
d Econo operation

- The diagram can be used for illustrative purposes only.
- The maximum running current and power consumption of the air conditioner in Econo operation varies with the connected outdoor unit.

4.3.7 OFF/ON timer operation

Timer functions are useful for automatically switching the air conditioner on/off at night or in the morning. You can also use OFF timer and ON timer in combination.

INFORMATION

Program the timer again in case of:

- A breaker has turned the unit off.
- A power failure.
- After replacing batteries in the user interface.

To start/stop OFF timer operation

Use this feature if the unit is operating and you want to stop operation after a certain time.

- 1 Press .

Result:  HR. is displayed on the LCD and the timer lamp lights up.

- 2 Press  again if you want to change the time setting.

INFORMATION

Each time  is pressed, the time setting advances by 1 hour. The timer can be set between 1 to 12 hours.

Example: If  HR. is set when the unit is operating, operation will stop after 5 hours.

- 3 To cancel the setting, press .

Result:  and the time setting disappear from the LCD and the timer lamp goes off.

INFORMATION

Night set mode

When the OFF timer is set, the air conditioner automatically adjusts the temperature setting (0.5°C up in cooling, 2.0°C down in heating) to prevent excessive cooling/heating and ensure a comfortable sleeping temperature.

To start/stop ON timer operation

Use this feature if the unit is NOT operating and you want to start operation after a certain time.

- 1 Press .

Result:  HR. is displayed on the LCD and the timer lamp lights up.

- 2 Press  again if you want to change the time setting.

INFORMATION

Each time  is pressed, the time setting advances by 1 hour. The timer can be set between 1 to 12 hours.

Example: If  HR. is set when the unit is NOT operating, operation will start after 2 hours.

- 3 To cancel the setting, press .

Result:  and the time setting disappear from the LCD and the timer lamp goes off.

To combine OFF timer and ON timer

- 1 To set the timers, refer to "To start/stop OFF timer operation" on page 7 and "To start/stop ON timer operation" on page 7.

Result: OFF and ON are displayed on the LCD.

Example:

- 2 If  is set when the unit is operating.

Result: Operation **stops** in 1 hour and then **starts** 7 hours later.

- 3 If  is set when the unit is NOT operating.

5 Energy saving and optimum operation

Result: Operation **starts** in 2 hours and then **stops** 3 hours later.

5 Energy saving and optimum operation



INFORMATION

- Even if the unit is turned OFF, it consumes electricity.
- When the power turns back on after a power break, the previously selected mode will be resumed.



CAUTION

NEVER expose little children, plants or animals directly to the airflow.



WARNING

Do NOT place objects below the indoor and/or outdoor unit that may get wet. Otherwise condensation on the unit or refrigerant pipes, air filter dirt or drain blockage may cause dripping, and objects under the unit may get dirty or damaged.



NOTICE

Do NOT use the system for other purposes. In order to avoid any quality deterioration, do NOT use the unit for cooling precision instruments, food, plants, animals, or works of art.



CAUTION

Do NOT operate the system when using a room fumigation-type insecticide. Chemicals could collect in the unit, and endanger the health of people who are hypersensitive to chemicals.



WARNING

Do NOT place a flammable spray bottle near the air conditioner and do NOT use sprays. Doing so may result in a fire.

Observe the following precautions to ensure the system operates properly.

- Prevent direct sunlight from entering a room during cooling operation by using curtains or blinds.
- Ventilate often. Extended use requires special attention to ventilation.
- Keep doors and windows closed. If the doors and windows remain open, air will flow out of your room causing a decrease in the cooling or heating effect.
- Be careful NOT to cool or heat too much. To save energy, keep the temperature setting at a moderate level.
- NEVER place objects near the air inlet or the air outlet of the unit. Doing so may cause a reduced heating/cooling effect or stop operation.
- Turn the breaker off when the unit is NOT used for longer periods of time. If the breaker is on, the unit consumes electricity. Before restarting the unit, turn the breaker on 6 hours before operation to ensure smooth running.
- Condensation may form if the humidity is above 80% or if the drain outlet gets blocked.
- Adjust the room temperature properly for a comfortable environment. Avoid excessive heating or cooling. Notice that it may take some time for the room temperature to reach the set temperature. Consider using the timer setting options.

- Adjust the air flow direction to avoid cool air from gathering on the floor or warm air against the ceiling. (Up during cooling or dry operation to the ceiling and down during heating operation.)
- Avoid direct air flow to room inhabitants.
- Operate the system within the recommended temperature range (26~28°C for cooling and 20~24°C for heating) to save energy.

6 Maintenance and service

6.1 Overview: Maintenance and service

The installer has to perform a yearly maintenance.

About the refrigerant

This product contains fluorinated greenhouse gases. Do NOT vent gases into the atmosphere.

Refrigerant type: R32

Global warming potential (GWP) value: 675



NOTICE

In Europe, the **greenhouse gas emissions** of the total refrigerant charge in the system (expressed as tonnes CO₂ equivalent) is used to determine the maintenance intervals. Follow the applicable legislation.

Formula to calculate the greenhouse gas emissions:
GWP value of the refrigerant × Total refrigerant charge [in kg] / 1000

Please contact your installer for more information.



WARNING

The refrigerant inside the unit is mildly flammable, but normally does NOT leak. If the refrigerant leaks in the room and comes in contact with fire from a burner, a heater, or a cooker, this may result in fire, or the formation of a harmful gas.

Turn off any combustible heating devices, ventilate the room, and contact the dealer where you purchased the unit.

Do NOT use the unit until a service person confirms that the part from which the refrigerant leaked has been repaired.



WARNING

- Do NOT pierce or burn refrigerant cycle parts.
- Do NOT use cleaning materials or means to accelerate the defrosting process other than those recommended by the manufacturer.
- Be aware that the refrigerant inside the system is odourless.



WARNING

The appliance shall be stored in a room without continuously operating ignition sources (example: open flames, an operating gas appliance or an operating electric heater).



NOTICE

Maintenance **MUST** be done by an authorized installer or service agent.

We recommend performing maintenance at least once a year. However, applicable legislation might require shorter maintenance intervals.



DANGER: RISK OF ELECTROCUTION

To clean the air conditioner or air filter, be sure to stop operation and turn all power supplies off. Otherwise, an electric shock and injury may result.



WARNING

To prevent electric shocks or fire:

- Do NOT rinse the unit.
- Do NOT operate the unit with wet hands.
- Do NOT place any objects containing water on the unit.



CAUTION

After a long use, check the unit stand and fitting for damage. If damaged, the unit may fall and result in injury.



CAUTION

Do NOT touch the heat exchanger fins. These fins are sharp and could result in cutting injuries.



WARNING

Be careful with ladders when working in high places.

6.2 To clean the indoor unit and user interface



NOTICE

- Do NOT use gasoline, benzene, thinner polishing powder or liquid insecticide. **Possible consequence:** Discoloration and deformation.
- Do NOT use water or air of 40°C or higher. **Possible consequence:** Discoloration and deformation.
- Do NOT use polishing compounds.
- Do NOT use a scrubbing brush. **Possible consequence:** The surface finishing peels off.



DANGER: RISK OF ELECTROCUTION

Before cleaning, be sure to stop the operation, turn the breaker off or pull out the supply cord. Otherwise, an electric shock and injury may result.

- 1 Clean with a soft cloth. If it is difficult to remove stains, use water or a neutral detergent.

6.3 To clean the front panel

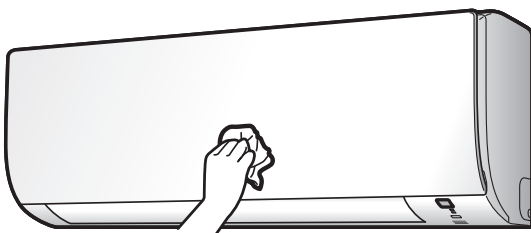

- 1 Clean the front panel with a soft cloth. If it is difficult to remove stains, use water or a neutral detergent.

6.4 To open the front panel

- 1 Hold the front panel by the panel tabs on both sides and open it.

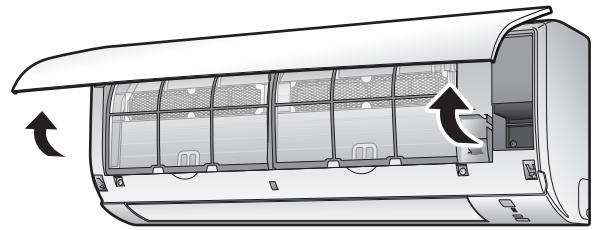

6.5 To clean the air filters

- 1 Push the tab at the centre of each air filter, then pull it down.
- 2 Pull out the air filters.

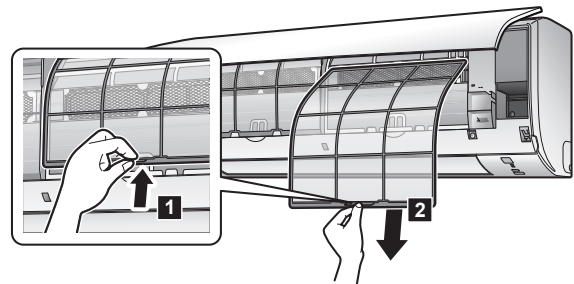

Note: (class 50~71) The titanium apatite deodorizing filter **MUST** be removed before cleaning the air filter.

- 3 Remove the titanium apatite deodorizing filter from all 4 claws.

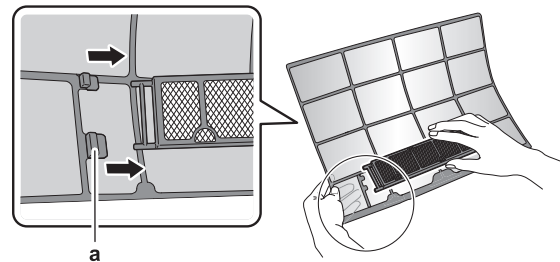

a Claw

- 4 Wash the air filters with water or clean them with a vacuum cleaner.

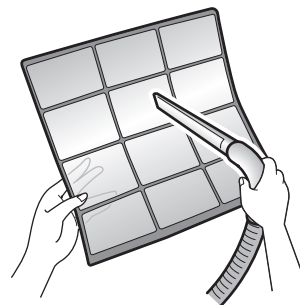

- 5 Soak in lukewarm water for about 10 to 15 minutes.



7 Troubleshooting

i INFORMATION

- If the dust does NOT come off easily, wash the air filters with a neutral detergent diluted in lukewarm water. Dry the air filters in the shade.
- Be sure to remove the titanium apatite deodorizing filter.
- It is recommended to clean the air filters every 2 weeks.

6.6 To clean the titanium apatite deodorizing filter

i INFORMATION

Clean the filter with water every 6 months.

- 1 Remove the titanium apatite deodorizing filter from the tabs (class 20~35) or all 4 claws (class 50~71).

Class 20~35

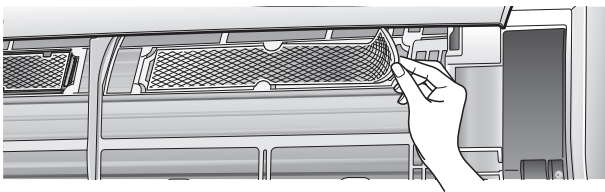

Class 50~71

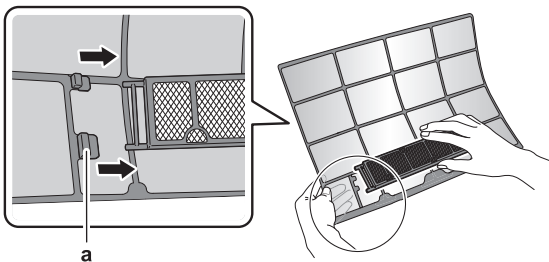

a
a Claw

- 2 Remove the dust from the filter with a vacuum cleaner.

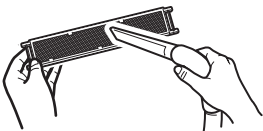

- 3 Soak the filter for 10 to 15 minutes in warm water.

Note: (class 50~71) Do NOT remove the filter from the frame.

Class 20~35

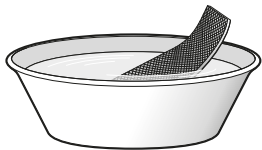

Class 50~71

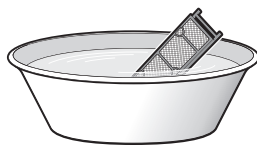

- 4 After washing, shake off remaining water and dry the filter in the shade. Do NOT wring out the filter when removing water.

6.7 To replace the titanium apatite deodorizing filter

i INFORMATION

Replace the filter every 3 years.

To order titanium apatite deodorizing filters, contact your dealer.

Item	Part number
Titanium deodorizing filter 1 set	KAF970A46

- 1 Remove the filter from the tabs (class 20~35) or frame (class 50~71) and replace the filter with a new one.

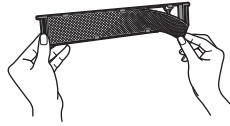

i INFORMATION

- Do NOT throw away the filter frame, but use it again.
- Dispose of the old filter as non-flammable waste.

6.8 To close the front panel

- 1 Install the air filters and the titanium apatite deodorizing filters back in their original positions.
- 2 Gently press the front panel at both sides and at the center until it clicks.

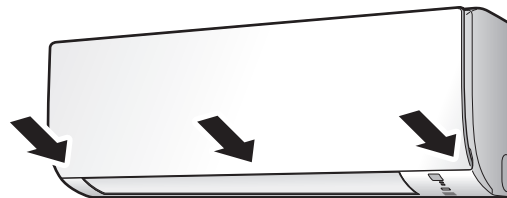

6.9 To take following items into account before a long idle period

- 1 Set the mode to **fan only** by pressing **FAN ONLY** button to dry the inside of the unit.
- 2 After operation stops, turn the breaker off.
- 3 Clean the air filters and replace them in their original position.
- 4 Remove the batteries from the user interface.

i INFORMATION

It is recommended to have periodical maintenance performed by a specialist. For specialist maintenance, contact your dealer. Maintenance costs shall be borne by the customer.

In certain operating conditions the inside of the unit may get dirty after several seasons of use. This results in poor performance.

7 Troubleshooting

If one of the following malfunctions occur, take the measures shown below and contact your dealer.

! WARNING

Stop operation and shut off the power if anything unusual occurs (burning smells etc.).

Leaving the unit running under such circumstances may cause breakage, electric shock or fire. Contact your dealer.

The system **MUST** be repaired by a qualified service person:

Malfunction	Measure
If a safety device such as a fuse, a breaker or an earth leakage breaker frequently actuates or the ON/OFF switch does NOT properly work.	Turn OFF the main power switch.
If water leaks from the unit.	Stop the operation.
The operation switch does NOT work well.	Turn OFF the power supply.
If the user interface display indicates the unit number, the operation lamp flashes and the malfunction code appears.	Notify your installer and report the malfunction code.

If the system does NOT properly operate except for the above mentioned cases and none of the above mentioned malfunctions is evident, investigate the system according to the following procedures.

Malfunction	Measure
If the system does NOT operate at all.	<ul style="list-style-type: none"> Check if there is no power failure. Wait until power is restored. If a power failure occurs during operation, the system automatically restarts immediately after power is restored. Check if no fuse has blown or breaker is activated. Change the fuse or reset the breaker if necessary. Check the batteries of the user interface.
The system suddenly stops operating.	<ul style="list-style-type: none"> Check if the air inlet or outlet of the outdoor or indoor unit is NOT blocked by obstacles. Remove any obstacles and make sure the air can flow freely. The air conditioner may stop operating after sudden large voltage fluctuations to protect the system. It automatically resumes operation after about 3 minutes.
The system operates, but cooling or heating is insufficient.	<ul style="list-style-type: none"> Check the airflow rate setting. Refer to "4.3.2 Airflow rate" on page 5. Check the temperature setting. Refer to "4.3.1 To start/stop operation and to set the temperature" on page 5. Check if the airflow direction setting is appropriate. Refer to "4.3.3 Airflow direction" on page 6. Check if the air inlet or outlet of the outdoor or indoor unit is NOT blocked by obstacles. Remove any obstacles and make sure the air can flow freely.
The system operates, but cooling or heating is insufficient (air is NOT blown from the unit).	<ul style="list-style-type: none"> The air conditioner may be warming up for heating operation. Wait for 1 to 4 minutes. The unit may be in defrost operation.
The system operates, but cooling or heating is insufficient (air is blown from the unit).	<ul style="list-style-type: none"> Check if the air filters are clogged. Clean the air filters. See "6 Maintenance and service" on page 8. Check for open doors or windows. Close doors and windows to prevent wind from coming in. Check if the unit operates in Econo operation. Refer to "4.3.6 Econo operation" on page 7. Check if there is any furniture directly under or next to the indoor unit. Move the furniture.

Malfunction	Measure
An abnormal function happens during operation.	The air conditioner may malfunction because of lightning or radio waves. Turn the breaker OFF and back ON.
The unit does NOT receive signals from the user interface.	<ul style="list-style-type: none"> Check the batteries of the user interface. Make sure that the transmitter is NOT exposed to direct sunlight. Check if there are any electronic starter type fluorescent lamps in the room. Contact your dealer.
The user interface display is blank.	Replace the batteries of the user interface.
An error code is displayed on the user interface.	Consult your local dealer. Refer to "7.2 Solving problems based on error codes" on page 12 for a detailed list of error codes.
Other electric appliances start to operate.	If the user interface signals operate other electric appliances, move the other appliances away, and contact your dealer.

If after checking all above items, it is impossible to fix the problem yourself, contact your installer and state the symptoms, the complete model name of the unit (with manufacturing number if possible) and the installation date (possibly listed on the warranty card).

7.1 Symptoms that are NOT system malfunctions

The following symptoms are NOT system malfunctions:

7.1.1 Symptom: A sound like water flowing is heard

- This sound is caused by the refrigerant flowing in the unit.
- This sound may be generated when water is flowing away from the unit during cooling or drying operation.

7.1.2 Symptom: A blowing sound is heard

This sound is generated when the direction of the refrigerant flow is changed (e.g. when switching from cooling to heating).

7.1.3 Symptom: A ticking sound is heard

This sound is generated when the unit slightly expands or contracts with changes in temperature.

7.1.4 Symptom: A whistling sound is heard

This sound is generated by the refrigerant flowing during defrost operation.

7.1.5 Symptom: A clicking sound during operation or idle time is heard

This sound is generated when the refrigerant control valves or electrical parts operate.

7.1.6 Symptom: A clapping sound is heard

This sound is generated when an external device sucks air out of the room (e.g. exhaust fan, extractor hood) while the doors and windows in the room are closed. Open the doors or windows, or turn off the device.

7.1.7 Symptom: The units can give off odours

The unit can absorb the smell of rooms, furniture, cigarettes, etc., and then emit it again.

8 Disposal

7.1.8 Symptom: The outdoor fan rotates while the air conditioner is not in operation

- **After operation has stopped.** The outdoor fan continues to rotate for another 30 seconds for system protection.
- **While the air conditioner is not in operation.** When the outdoor temperature is very high, the outdoor fan starts to rotate for system protection.

7.2 Solving problems based on error codes

When a problem happens, an error code appears on the user interface. It is important to understand the problem and to take measures before resetting an error code. This should be done by a licensed installer or by your local dealer.



This chapter gives you an overview of all error codes and the content of the error code as it appears on the user interface.

For a more detailed troubleshooting guideline for each error, please see the service manual.

Fault diagnosis by user interface

The user interface can receive an error code from the indoor unit referring to the fault. It is important to understand the problem and take measures before resetting the error code. This should be done by a licensed installer or your local dealer.

To see the error code on the user interface:

- 1 Hold  for about 5 seconds.
Result:  blinks in the temperature display section.
- 2 Press  repeatedly until a continuous beep is heard.
Result: The code is now displayed on the display.



INFORMATION

- A short beep and 2 consecutive beeps indicate non-corresponding codes.
- To cancel the code display, hold the  cancel button for 5 seconds. The code will also disappear from the display if the button is NOT pressed within 1 minute.

System

Error code	Description
00	Normal
U0	Refrigerant shortage
U2	Overvoltage detection
U4	Signal transmission error (between indoor and outdoor unit)
UR	Indoor/outdoor unit combination fault

Indoor unit

Error code	Description
R1	Indoor unit PCB abnormality
R5	Freeze-up protection or high-pressure control
R6	Fan motor (DC motor) abnormality
L4	Indoor heat exchanger thermistor abnormality
L9	Room temperature thermistor abnormality

Outdoor unit

Error code	Description
E8	4-way valve abnormality
E1	Outdoor unit PCB abnormality

Error code	Description
E5	Overload activation (compressor overload)
E6	Compressor lock
E7	DC fan lock
E8	Input power overcurrent
F3	Discharge pipe temperature control
F6	High-pressure control (in cooling mode)
H0	Compressor system sensor abnormality
H6	Position sensor abnormality
H8	DC voltage / current sensor abnormality
H9	Outdoor temperature thermistor abnormality
J3	Discharge pipe thermistor abnormality
J6	Outdoor heat exchanger thermistor abnormality
L3	Electrical parts heat error
L4	Radiation fin temperature rise
L5	Inverter instantaneous overcurrent (DC)
P4	Radiation fin thermistor abnormality
F8	Compressor internal temperature error

8 Disposal



NOTICE

Do NOT try to dismantle the system yourself: dismantling of the system, treatment of the refrigerant, oil and other parts MUST comply with applicable legislation. Units MUST be treated at a specialised treatment facility for reuse, recycling and recovery.







ERC



DAIKIN INDUSTRIES CZECH REPUBLIC s.r.o.
U Nové Hospody 1/1155, 301 00 Plzeň Skvrňany, Czech Republic

DAIKIN EUROPE N.V.
Zandvoordestraat 300, B-8400 Oostende, Belgium

Copyright 2017 Daikin

3P511999-1C 2018.01